



## 20 SERIES EXIT DEVICE



Jackson's 20 Series Exit device is designed to withstand the rigors of today's world yet remain aesthetically pleasing. Each part is manufactured from the highest quality materials, which are hand fitted and adjusted for a smooth, whisper quiet operation. Available in both a Rim and Concealed Vertical Rod models, this device is suitable for use with narrow, medium and wide stile aluminum, wood or hollow metal doors.

### TECHNICAL INFORMATION

#### FEATURES

- Handed - Not Reversible
- Available as Rim and Concealed Vertical Rod.
- Certified ANSI 156.3 Grade 1.
- Concealed Vertical Rod model is available with either Top Bolt or Top Latch design.
- Available with Key Controlled and matching inactive dummy trim.
- Concealed easy to use dogging system
- Optional Front Dogging or Cylinder Dogging available
- Concealed fastening for added security
- "Soft Touch" smooth action push pad
- Durable external and internal components for long lasting, dependable service.
- Quick and easy installation
- UL Listed for Panic Hardware
- Trim available for the 20 Series

#### MATERIALS

Base Extrusion	Extruded Aluminum
Push Pad	Extruded Aluminum
Active Housing & End Caps	Die Cast Aluminum
Mechanical Components	Stainless & Hardened Steel
Top and Bottom Bolts	Plated Hardened Steel
Top & Rim Latch	Sintered Steel
Strikes	Sintered Steel

#### FINISH

Standard Anodized Finish:	DBZ 313	- Dark Bronze
	US28/628	- Satin Aluminum
Standard Architectural Finish:	US26/625	- Polished Chrome
	US3/605	- Polished Brass

### DIMENSIONS - Inch (Metric)

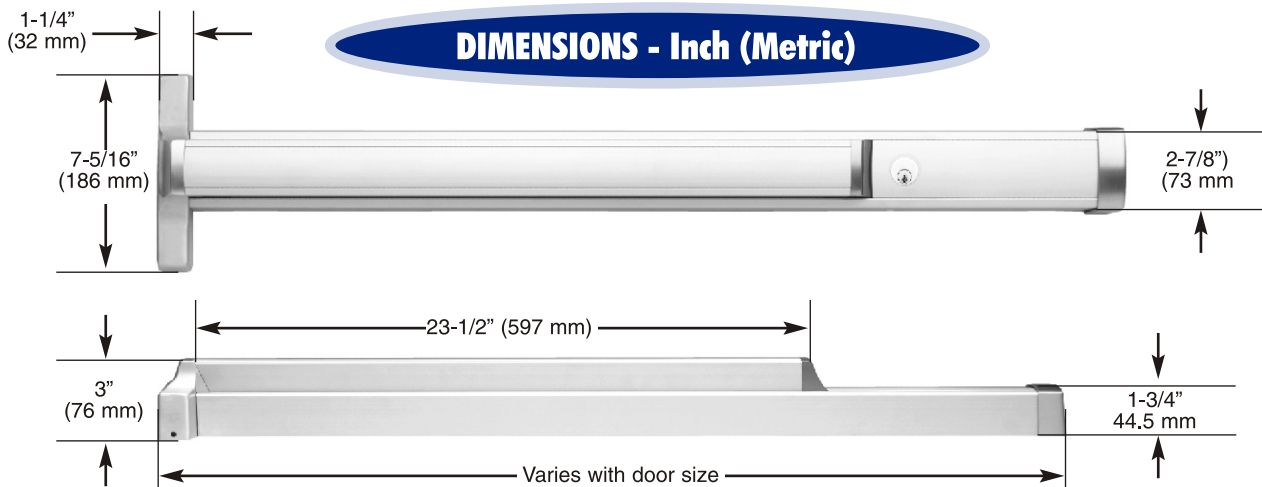



## 20 SERIES EXIT DEVICE

### 2085 & 2086 CONCEALED VERTICAL ROD



#### APPLICATION

- 1-3/4" (45 mm) Narrow , Medium and Wide Stile Aluminum Doors.
- Product is shipped for use with standard 1-3/4" (45 mm) Thick Doors - 2" (51 mm) Door Mounting is optional.

#### FEATURES

- Handed - Not Reversible
- Adjustable bolt guides allow bolt adjustment with door installed.
- Requires No. 30-821J Cylinder mounting pad when using mortise cylinder for keyed entry.
- Uses standard mortise cylinder with maximum security (MS) type cam. (Supplied by Others)
- Foam rubber silencers to quiet rod operation.
- Standard mounting package consists of machine screw type fasteners.
- Touchbar mounting height centerline at 38" (965 mm) from bottom of door.

### 2085 TOP LATCH

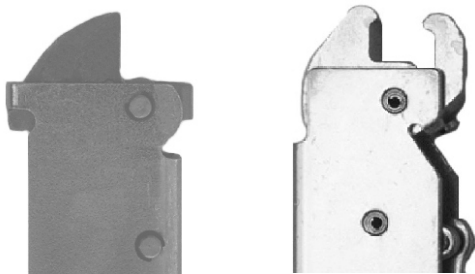

- Positive locking, spring loaded top latch design for increased security.
- Rod length shipped standard for 7/0 (2134 mm) high doors.  
For doors over 7/0 (2134 mm) High:  
Top Rod Extender - 12" (305 mm) . . . . . No. 30-1347  
Top Rod Extender - 24" (609 mm) . . . . . No. 30-1348
- Top Strike . . . . . No. 30-1305
- Bottom Bolt . . . . . No. 30-763P
- Bottom Strike . . . . . No. 30-412
- Pullman Latch (Optional) . . . . . No. 30-2770

### 2086 TOP BOLT

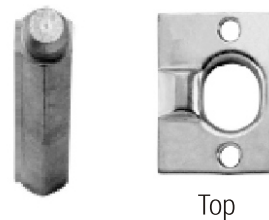

- Independent top and bottom bolt action - 1/2" (13 mm) bolt throw.
- Trigger action, positive bolt release
- Rod length shipped standard for 7/0 (2134 mm) high doors.  
For doors over 7/0 (2134 mm) High:  
Top Rod Extender - 12" (305 mm) . . . . . No. 30-1347  
Top Rod Extender - 24" (609 mm) . . . . . No. 30-1348
- Top & Bottom Bolt . . . . . No. 30-763P
- Top & Bottom Strikes . . . . . No. 30-1084



## 20 SERIES EXIT DEVICE

### 2095 RIM EXIT DEVICE



#### APPLICATION

- Aluminum, Wood or Hollow Metal Doors.

#### FEATURES

- Uses standard rim cylinder for keyed entry - mounting pad not necessary. (Cylinder supplied by others).
- 3/4" (19 mm) Throw Deadlocking Latchbolt.
- Standard mounting package consists of machine screw type fasteners - Optional Wood Door Mounting Kit No. 30-2521
- Adjustable Strike Options:
 

Surface Mounted Strike:	Type "C" (Standard).....No. 30-2436
Surface Mounted for use with Applied or Blade Stop:	Type "S" .....No. 30-2501

Surface Mounted  
Strike - Type "C" (Standard)

No. 30-2436



Surface Mounted  
for use with applied or  
blade stop - Type "S"

No. 30-2501

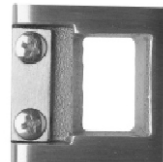

See **Access Control** section for more options.



## 20 SERIES EXIT DEVICE

### ACCESSORIES



For Doors Over 7/0 (2134 mm) High w/Top Bolt (2086):  
Top Rod Extender - 12" (305 mm) . . . No. 30-1347  
Top Rod Extender - 24" (609 mm) . . . No. 30-1348

Top & Bottom Bolt

No. 30-763P



Mortise Cylinder  
Mounting Pad

No. 30-821J



Top & Bottom  
Strikes - 2085:

No. 30-1345

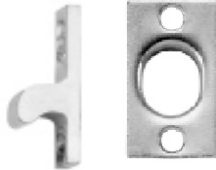

Signal Switch  
No. 30-2989

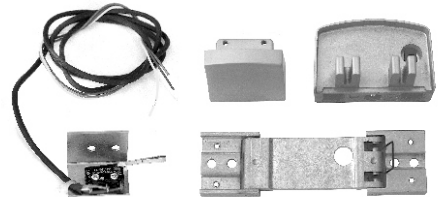

Top & Bottom  
Strikes - 2086

No. 30-1084

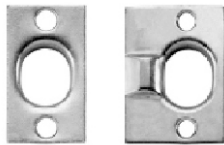

Bottom

Top

Adjustable  
Top & Bottom  
bolt guides

Top = No. 30-934  
Bottom = No. 30-321

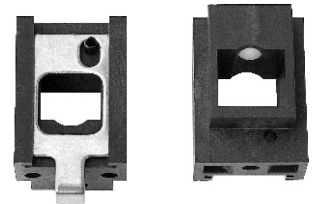

#### Rim Strike Options - 2095

Surface Mounted  
Strike - Type "C" (Standard)

No. 30-2436



Surface Mounted  
for use with Applied or  
Blade stop - Type "S"

No. 30-2501

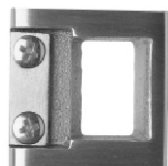

Concealed Vertical  
Rod Silencers

No. 30-1552



Top Bolt Trip

No. 30-824



Wood Door Mounting Kit  
for 2095 Rim Device

No. 30-2521

